

OSKO-PLAST
 Stara Dąbia 9, 08-500 Ryki
 www.osko-plast.pl

TYTUŁ:

Podsiewacz
 NH 1530

NR RYSUNKU

NH1530.PD.001

MATERIAŁ:

A4

SKALA:1:15

ARKUSZ 1 Z 5

NR ELEMENTU	NUMER CZĘŚCI	OPIS	ILOŚĆ
1	NH_1530_P_podloga	#1	1
2	NH_1530_P_bok	#2	1
3	LustroNH_1530_P_bok	#2	1
4	NH_1530_P_przegroda	#1	3
5	NH_1530_P_guma	#4 60x1875	2
6	NH_1530_P_katownik_p rzod	#2	1
7	NH_1530_P_MocG	uniwersalne	2
8	nit	nit 5	38
9	nakrętka M10	czarna zwykła	6
10	NH_1530_P_profil tyl	#3	1
11	NH_1530_P_pret_fi8	L=100	2
12	NH_1530_P_grzebien	#1	4

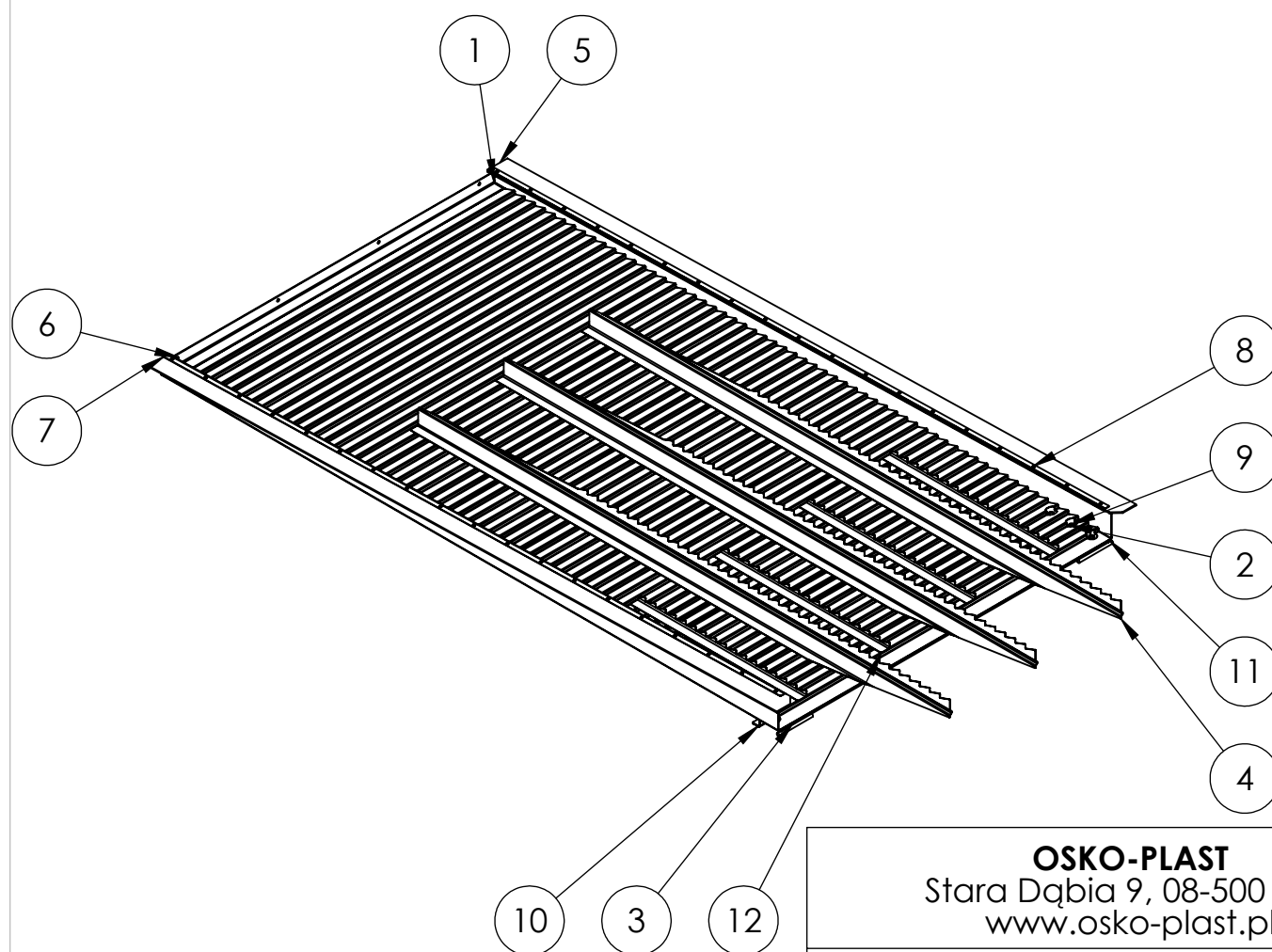

OSKO-PLAST
 Stara Dąbia 9, 08-500 Ryki
www.osko-plast.pl

TYTUŁ:

Podsiewacz
 NH 1530

NR RYSUNKU

NH1530.PD.002

MATERIAŁ:

A4

SKALA:1:15

ARKUSZ 2 Z 5

2. Bok LiP - matryc 1-16-88

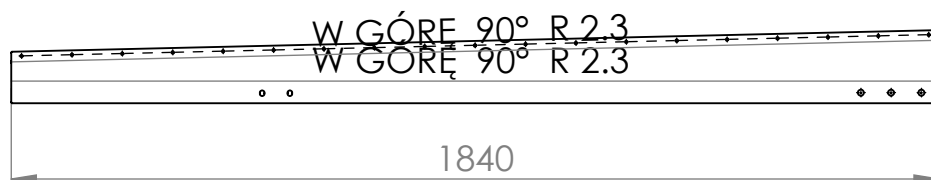
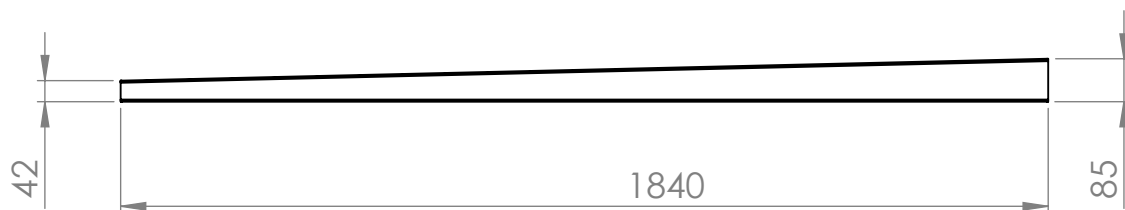
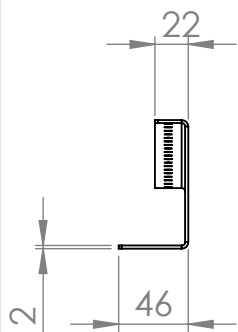

6. Kątownik przód - matryc 1-16-88

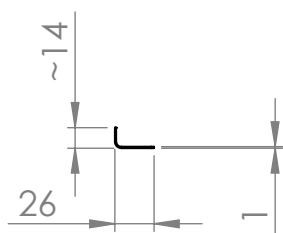

12. Grzebień - matryca 1-16-88

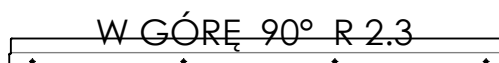
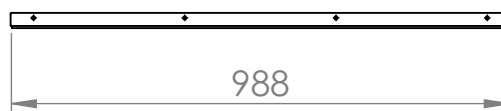
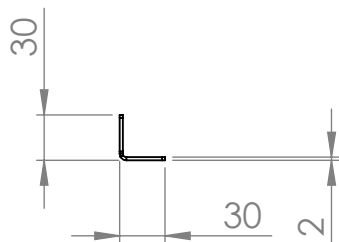

OSKO-PLAST
Stara Dąbia 9, 08-500 Ryki
www.osko-plast.pl

TYTUŁ:

Detale

NR RYSUNKU

NH1530.PD.003

MATERIAŁ:

A4

SKALA:1:15

ARKUSZ 3 Z 5

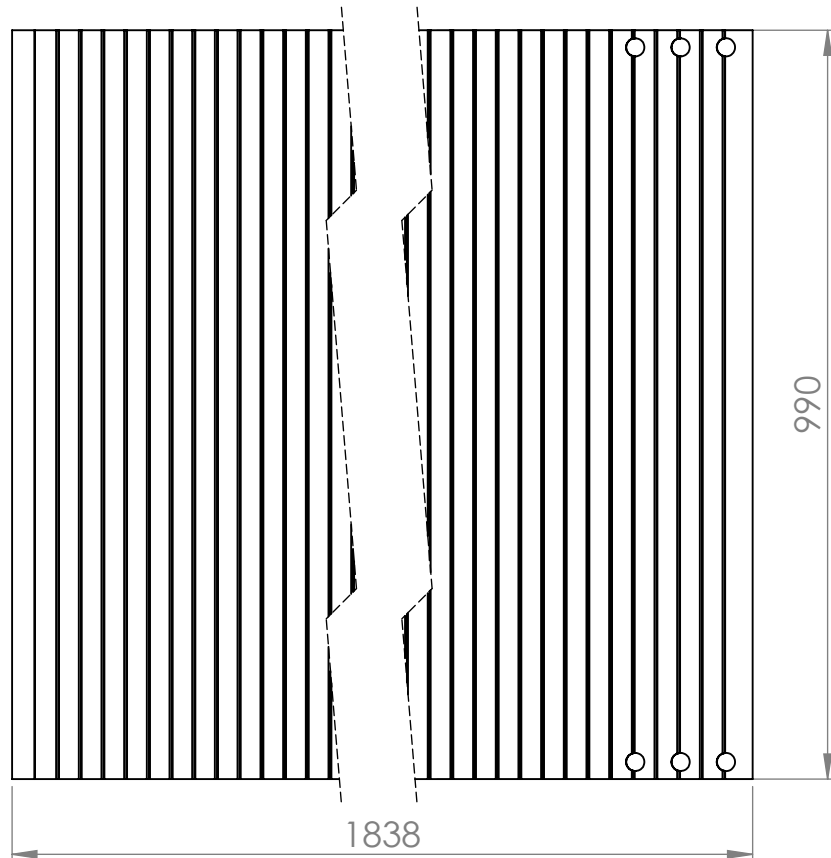
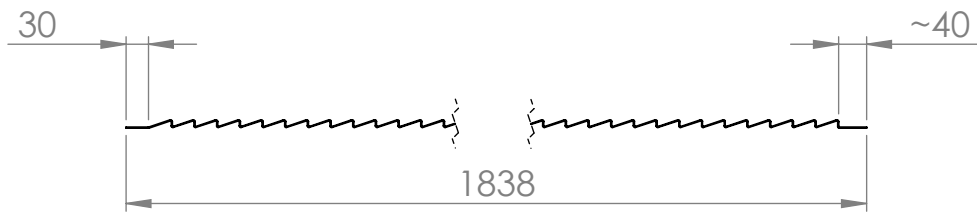

OSKO-PLAST
 Stara Dąbia 9, 08-500 Ryki
 www.osko-plast.pl

TYTUŁ:

BPP

NR RYSUNKU

NH1530.PD.004

MATERIAŁ:

A4

SKALA: 1:10

ARKUSZ 4 Z 5

10. profil tyl - matryca 2-22-88

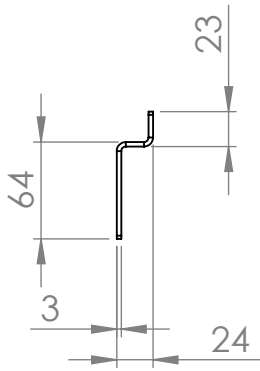

W GÓRĘ 90° R 3
W DÓŁ 90° R 3

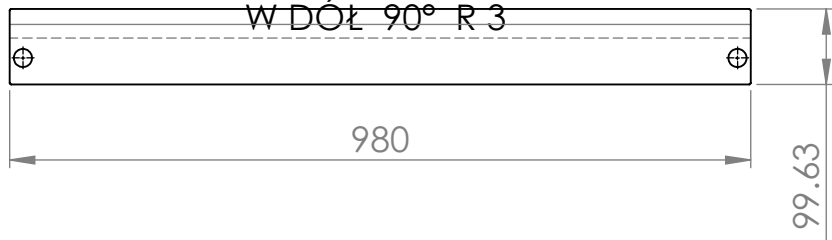

4. przegroda

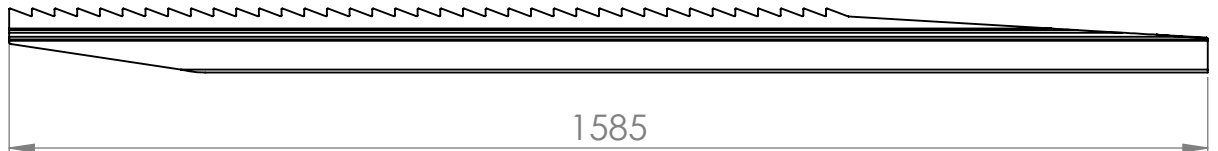
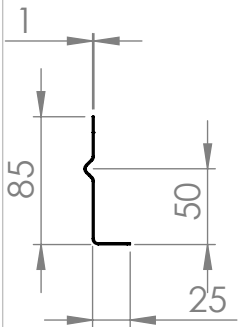

OSKO-PLAST
Stara Dąbia 9, 08-500 Ryki
www.osko-plast.pl

TYTUŁ:

Detale

NR RYSUNKU

NH1530.PD.005

MATERIAŁ:

A4

SKALA: 1:10

ARKUSZ 5 Z 5